

P-Channel Enhancement Mode Power MOSFET

Description

The PTD30P55 uses advanced trench technology and design to provide excellent $R_{DS(ON)}$ with low gate charge. It can be used in a wide variety of applications.

General Features

- $V_{DS} = -55V, I_D = -30A$
 $R_{DS(ON)} < 40m\Omega @ V_{GS} = -10V$
- High density cell design for ultra low R_{dson}
- Fully characterized avalanche voltage and current
- Good stability and uniformity with high E_{AS}
- Excellent package for good heat dissipation

Application

- Power switching application
- Hard switched and high frequency circuits
- Uninterruptible power supply

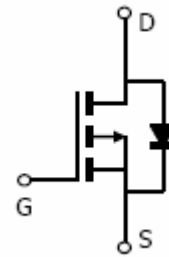

Schematic diagram

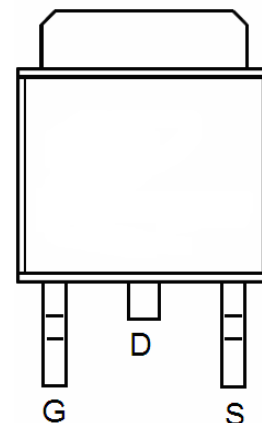

Marking and pin assignment

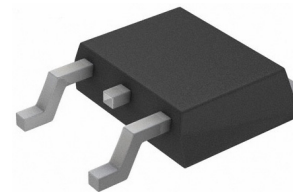

TO-252-2L top view

Absolute Maximum Ratings ($T_C = 25^\circ C$ unless otherwise noted)

Parameter	Symbol	Limit	Unit
Drain-Source Voltage	V_{DS}	-55	V
Gate-Source Voltage	V_{GS}	± 20	V
Drain Current-Continuous	I_D	-30	A
Drain Current-Continuous($T_C = 100^\circ C$)	$I_D(100^\circ C)$	-21	A
Pulsed Drain Current	I_{DM}	110	A
Maximum Power Dissipation	P_D	90	W
Derating factor		0.72	W/ $^\circ C$
Single pulse avalanche energy (Note 5)	E_{AS}	420	mJ

Operating Junction and Storage Temperature Range	T_J, T_{STG}	-55 To 150	°C
--	----------------	------------	----

Thermal Characteristic

Thermal Resistance, Junction-to-Case(Note 2)	$R_{\theta JC}$	1.39	°C/W
--	-----------------	------	------

Electrical Characteristics ($T_C=25^\circ\text{C}$ unless otherwise noted)

Parameter	Symbol	Condition	Min	Typ	Max	Unit
Off Characteristics						
Drain-Source Breakdown Voltage	BV_{DSS}	$V_{GS}=0V, I_D=-250\mu A$	-55	-	-	V
Zero Gate Voltage Drain Current	I_{DSS}	$V_{DS}=-55V, V_{GS}=0V$	-	-	1	μA
Gate-Body Leakage Current	I_{GSS}	$V_{GS}=\pm 20V, V_{DS}=0V$	-	-	± 100	nA
On Characteristics (Note 3)						
Gate Threshold Voltage	$V_{GS(th)}$	$V_{DS}=V_{GS}, I_D=-250\mu A$	-2	-3	-4	V
Drain-Source On-State Resistance	$R_{DS(on)}$	$V_{GS}=-10V, I_D=-15A$	-	30	40	m Ω
Forward Transconductance	g_{FS}	$V_{DS}=-25V, I_D=-16A$	8	-	-	S
Dynamic Characteristics (Note 4)						
Input Capacitance	C_{iss}	$V_{DS}=-30V, V_{GS}=0V,$ $F=1.0\text{MHz}$	-	3500	-	PF
Output Capacitance	C_{oss}		-	240	-	PF
Reverse Transfer Capacitance	C_{rss}		-	153	-	PF
Switching Characteristics (Note 4)						
Turn-on Delay Time	$t_{d(on)}$	$V_{DD}=-30V, I_D=-15A$ $V_{GS}=-10V, R_{GEN}=3\Omega$	-	12	-	nS
Turn-on Rise Time	t_r		-	15	-	nS
Turn-Off Delay Time	$t_{d(off)}$		-	38	-	nS
Turn-Off Fall Time	t_f		-	15	-	nS
Total Gate Charge	Q_g	$V_{DS}=-44V, I_D=-16A,$ $V_{GS}=-10V$	-	56	-	nC
Gate-Source Charge	Q_{gs}		-	11	-	nC
Gate-Drain Charge	Q_{gd}		-	24	-	nC
Drain-Source Diode Characteristics						
Diode Forward Voltage (Note 3)	V_{SD}	$V_{GS}=0V, I_S=-24A$	-	-	1.2	V
Diode Forward Current (Note 2)	I_S		-	-	-30	A
Reverse Recovery Time	t_{rr}	$T_J = 25^\circ\text{C}, I_F = -15A$ $di/dt = 100A/\mu\text{s}(\text{Note 3})$	-	-	71	nS
Reverse Recovery Charge	Q_{rr}		-	-	170	nC
Forward Turn-On Time	t_{on}	Intrinsic turn-on time is negligible (turn-on is dominated by LS+LD)				

Notes:

1. Repetitive Rating: Pulse width limited by maximum junction temperature.
2. Surface Mounted on FR4 Board, $t \leq 10$ sec.
3. Pulse Test: Pulse Width $\leq 300\mu\text{s}$, Duty Cycle $\leq 2\%$.
4. Guaranteed by design, not subject to production
5. E_{AS} condition: $T_J=25^\circ\text{C}, V_{DD}=-25V, V_G=-20V, L=0.5\text{mH}, R_g=25\Omega, I_{AS}=29A$

Test Circuit

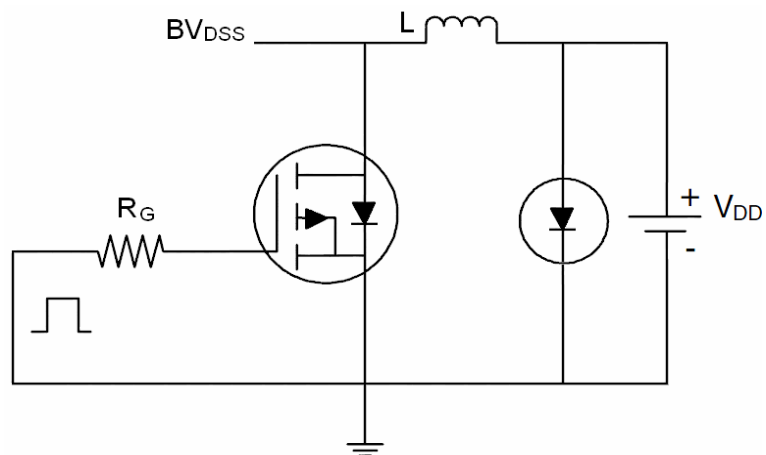
1) E_{AS} Test Circuit

2) Gate Charge Test Circuit

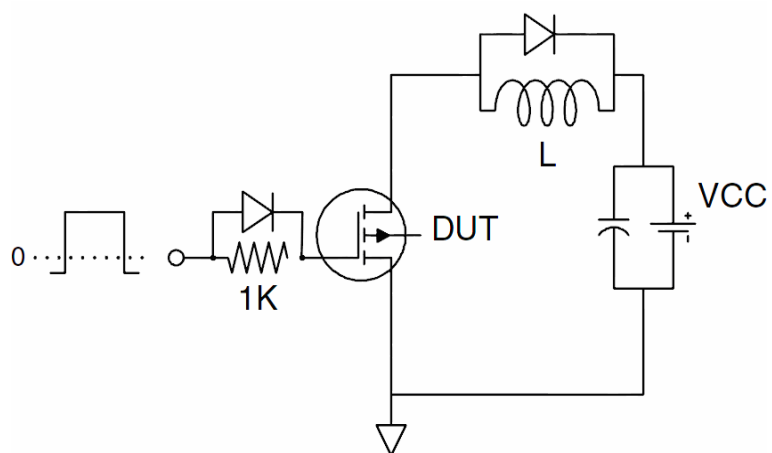

3) Switch Time Test Circuit

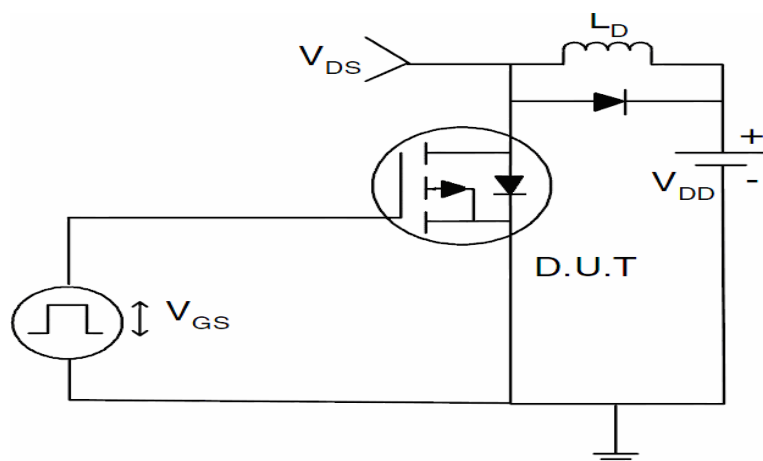

Typical Electrical and Thermal Characteristics (Curves)

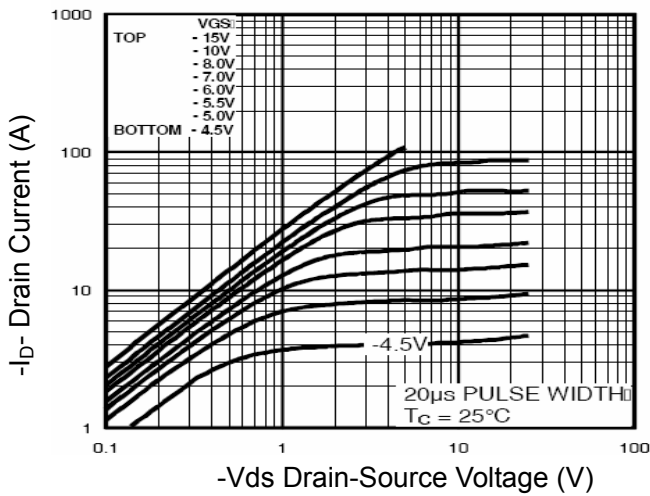

Figure 1 Output Characteristics

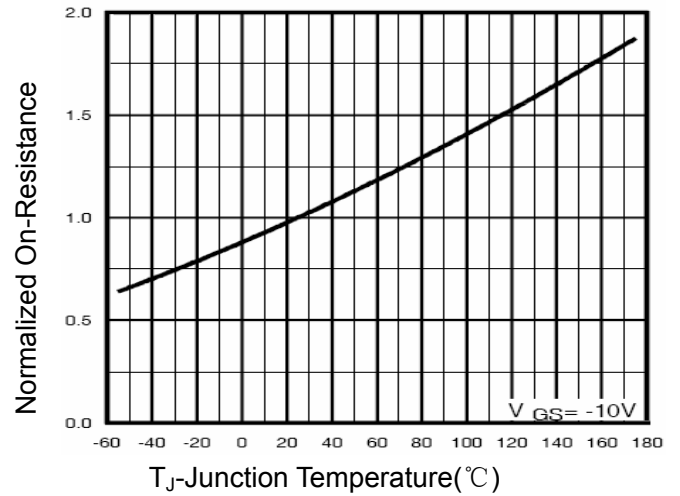

Figure 4 R_{dson} -Junction Temperature

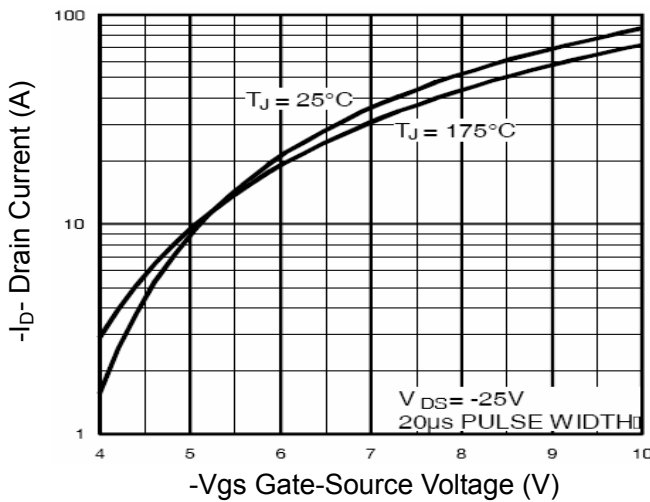

Figure 2 Transfer Characteristics

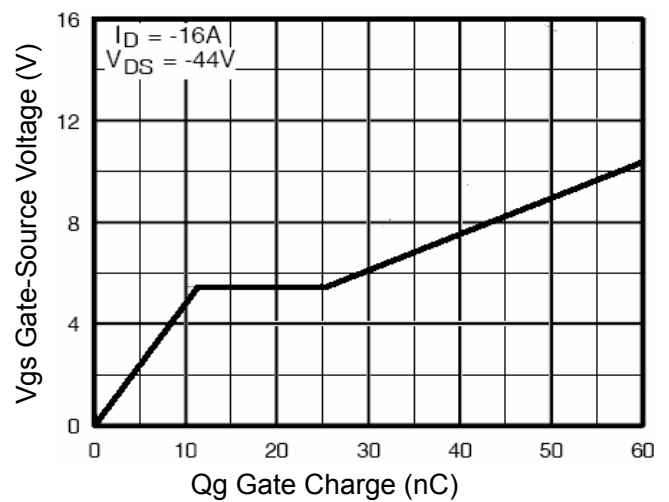

Figure 5 Gate Charge

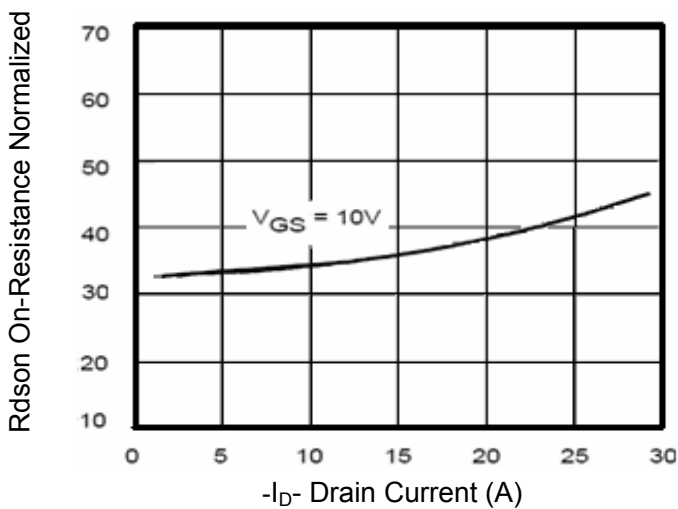

Figure 3 R_{dson} - Drain Current

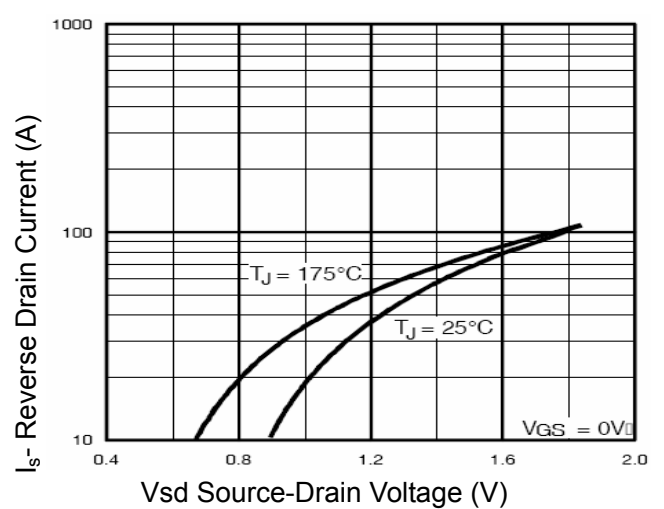

Figure 6 Source- Drain Diode Forward

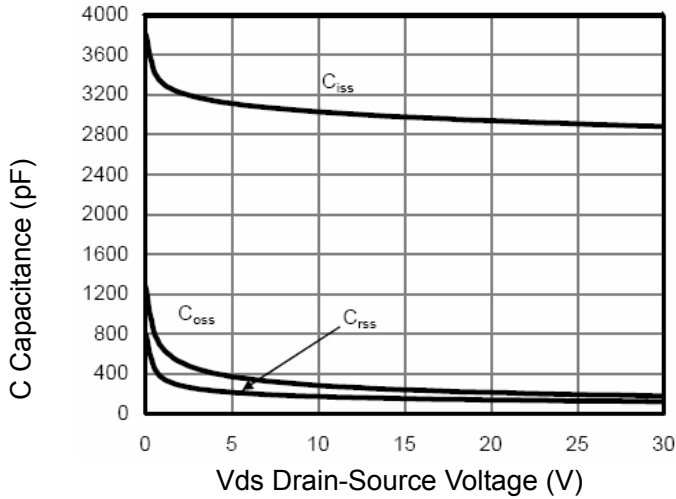

Figure 7 Capacitance vs Vds

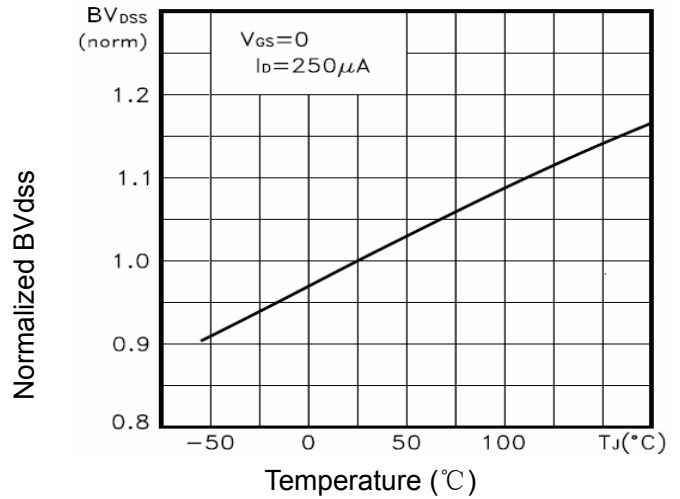

Figure 9 BV_{DSS} vs Junction Temperature

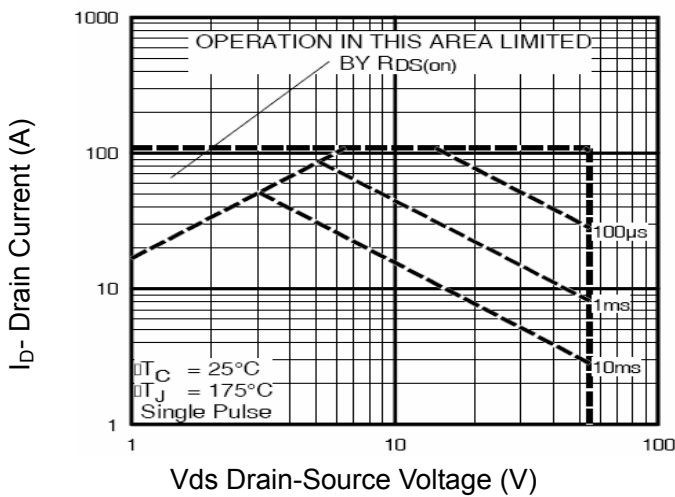

Figure 8 Safe Operation Area

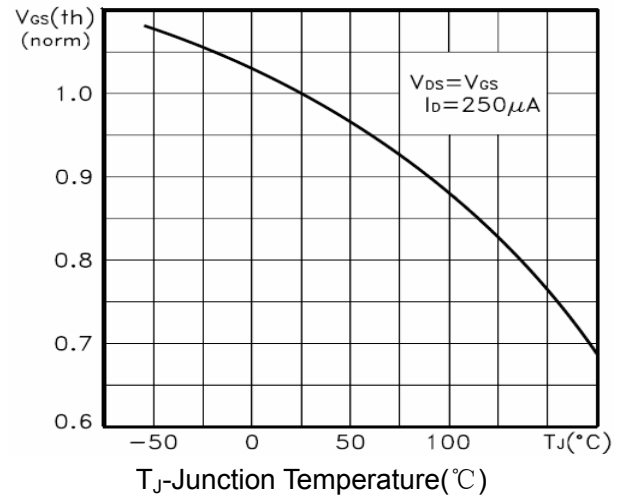

Figure 10 $V_{GS(th)}$ vs Junction Temperature

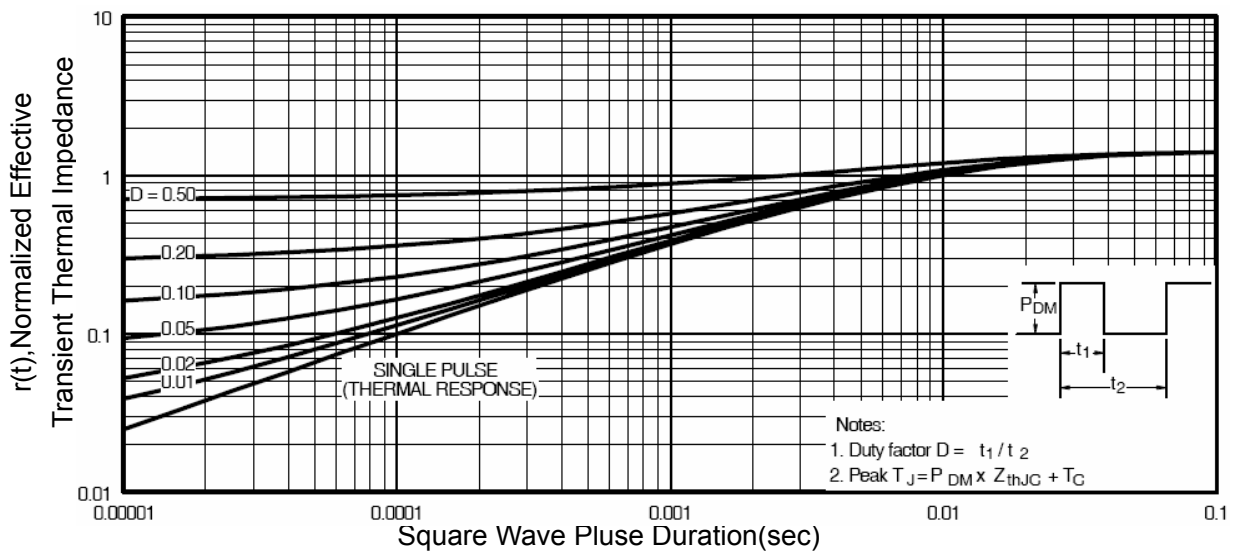
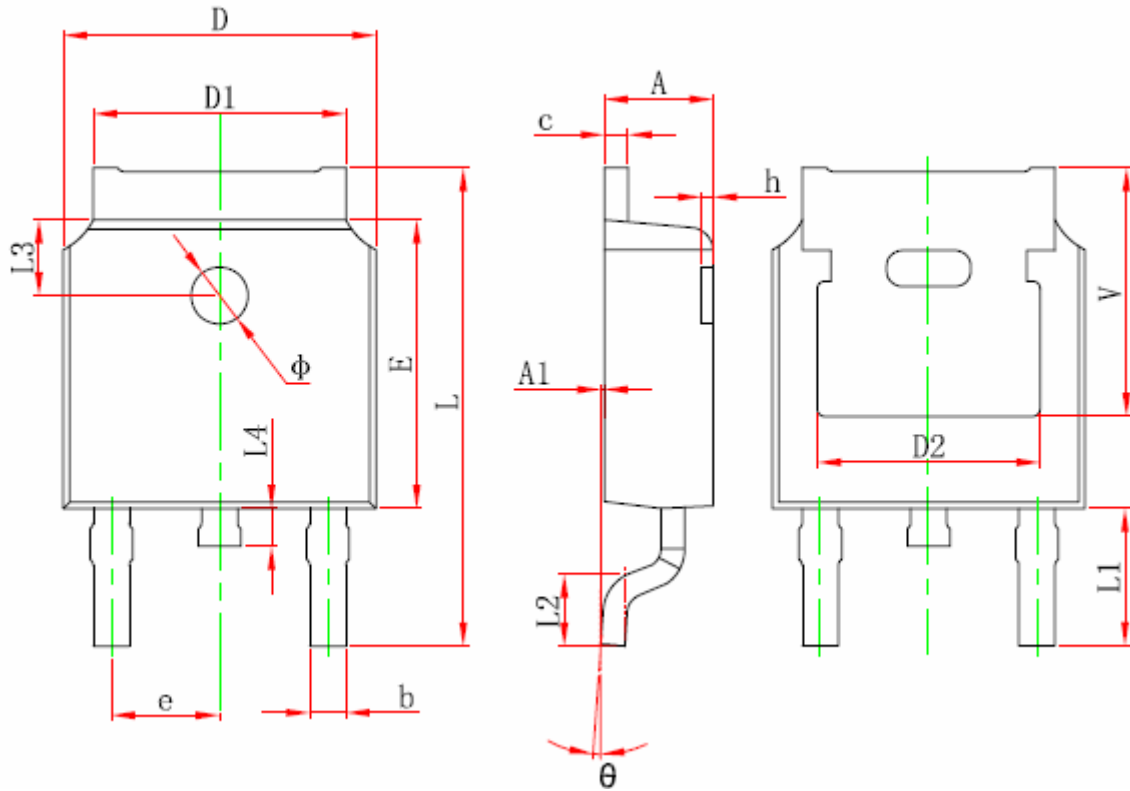

Figure 11 Normalized Maximum Transient Thermal Impedance

TO-252-2L Package Information



Symbol	Dimensions In Millimeters		Dimensions In Inches	
	Min.	Max.	Min.	Max.
A	2.200	2.400	0.087	0.094
A1	0.000	0.127	0.000	0.005
b	0.660	0.860	0.026	0.034
c	0.460	0.580	0.018	0.023
D	6.500	6.700	0.256	0.264
D1	5.100	5.460	0.201	0.215
D2	4.830 REF.		0.190 REF.	
E	6.000	6.200	0.236	0.244
e	2.186	2.386	0.086	0.094
L	9.800	10.400	0.386	0.409
L1	2.900 REF.		0.114 REF.	
L2	1.400	1.700	0.055	0.067
L3	1.600 REF.		0.063 REF.	
L4	0.600	1.000	0.024	0.039
φ	1.100	1.300	0.043	0.051
θ	0°	8°	0°	8°
h	0.000	0.300	0.000	0.012
V	5.350 REF.		0.211 REF.	