

2SK3018

30V N-Channel Enhancement Mode MOSFET

• Features

- 1) Low on-resistance.
- 2) Fast switching speed.
- 3) Low voltage drive (2.5V) makes this device ideal for portable equipment.
- 4) Easily designed drive circuits.
- 5) Easy to parallel.

• Applications

Interfacing, switching (30V, 100mA)

• Structure

Silicon N-channel
MOSFET

• External dimensions

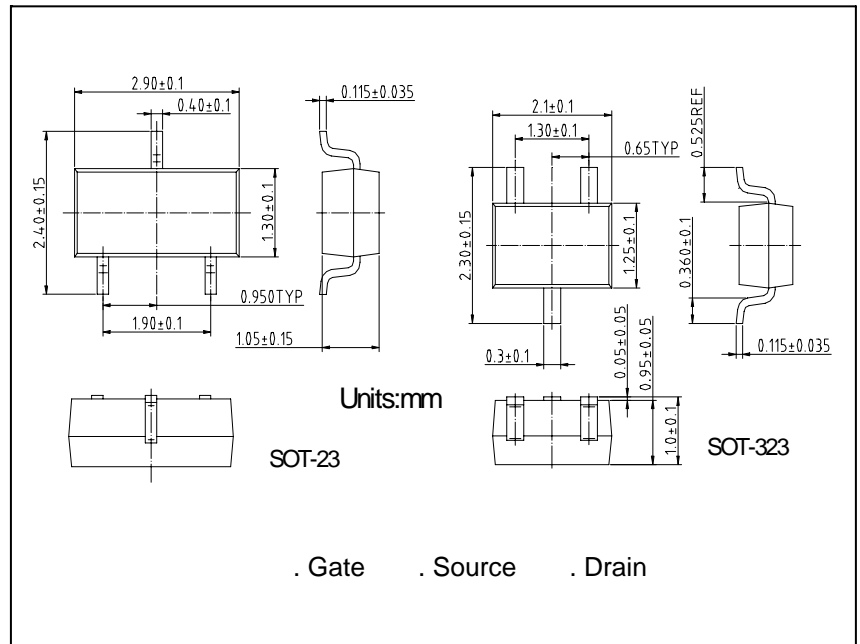

• Absolute maximum ratings (Ta = 25°C)

Parameter	Symbol	Limits	Unit
Drain-source voltage	V_{DSS}	30	V
Gate-source voltage	V_{GSS}	± 20	V
Drain current	Continuous	I_D	100 mA
	Pulsed	I_{DP*1}	200 mA
Reverse drain current	Continuous	I_{DR}	100 mA
	Pulsed	I_{DRP*1}	200 mA
Total power dissipation($T_c=25^\circ C$)	P_D*2	200	mW
Channel temperature	T_{ch}	150	$^\circ C$
Storage temperature	T_{stg}	-55~+150	$^\circ C$

*1Pw 10 μ s, Duty Cycle 50%

*2With each pin mounted on the recommended lands

• Equivalent circuit

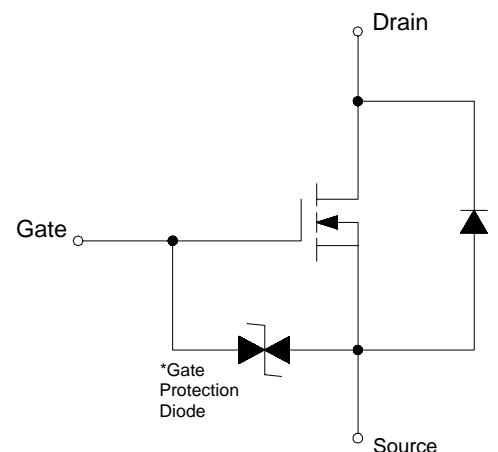

*A protection diode is included between the gate and the source terminals to protect the diode against static electricity when the product is in use. Use a protection circuit when the fixed voltages are exceeded.

• Electrical characteristics (Ta = 25°C)

Parameter	Symbol	Min.	Typ.	Max.	Unit	Test Conditions
Gate-source leakage	I_{GSS}	----	----	± 1	μA	$V_{GS}=\pm 20V, V_{DS}=0V$
Drain-source breakdown voltage	$V_{(BR)DS}$	30	----	----	V	$I_D=10\mu A, V_{GS}=0V$
Zero gate voltage drain current	I_{DSS}	----	----	1	μA	$V_{DS}=30V, V_{GS}=0V$
Gate threshold Voltage	$V_{GS(th)}$	0.8	----	1.5	V	$V_{DS}=3V, I_D=100\mu A$
Static drain-source on-state resistance	$R_{DS(ON)}$	----	5	8		$I_D=10mA, V_{GS}=4V$
	$R_{DS(ON)}$	----	7	13		$I_D=1mA, V_{GS}=2.5V$
Forward transfer admittance	Y_{fs}	20	----	----	mS	$V_{DS}=3V, I_D=10mA$
Input capacitance	C_{iss}	----	13	----	pF	$V_{DS}=5V$ $V_{GS}=0V$ $F=1\text{ MHz}$
Output capacitance	C_{oss}	----	9	----	pF	
Reverse transfer capacitance	C_{rss}	----	4	----	pF	
Turn-on delay time	$t_{d(on)}$	----	15		ns	$I_D=10\text{ mA}, V_{DO}=5V$ $V_{GS}=5V$ $R_L=500$ $R_{GS}=10$
Rise time	t_r	----	35		ns	
Turn-off delay time	$t_{d(off)}$	----	80		ns	
Fall time	t_f	----	80		ns	

• Packaging specifications

Type	Package	Taping
	Code	T106
	Basic ordering unit (pieces)	3000
2SK3018		

• Electrical characteristic curves

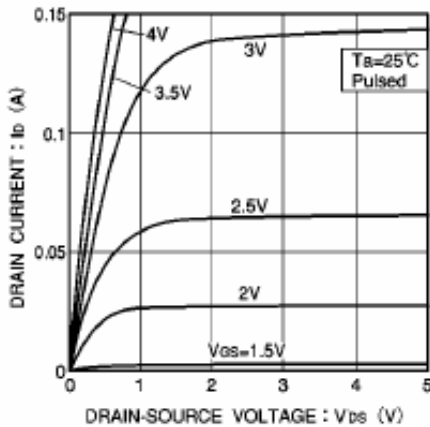

Fig.1 Typical output characteristics

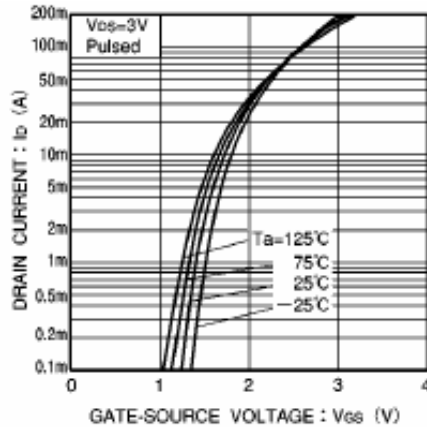

Fig.2 Typical transfer characteristics

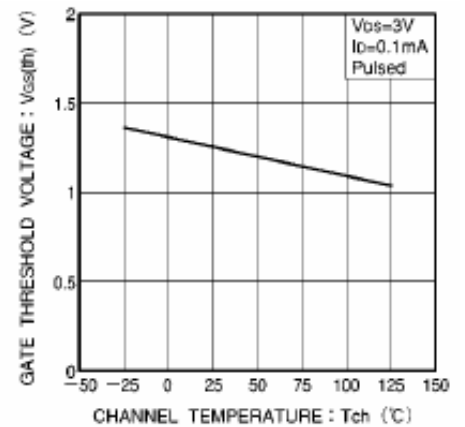

Fig.3 Gate threshold voltage vs. channel temperature

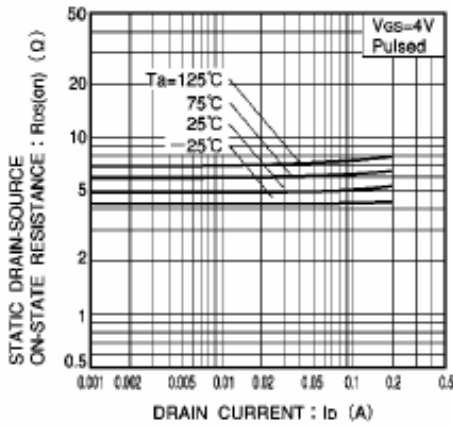

Fig.4 Static drain-source on-state resistance vs. drain current (I)

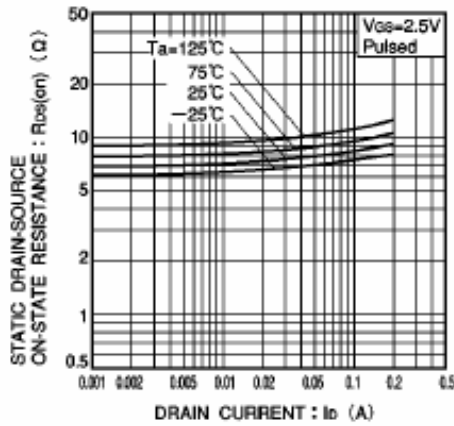

Fig.5 Static drain-source on-state resistance vs. drain current (II)

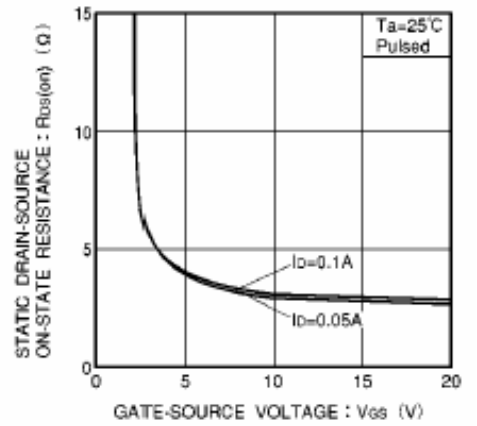

Fig.6 Static drain-source on-state resistance vs. gate-source voltage

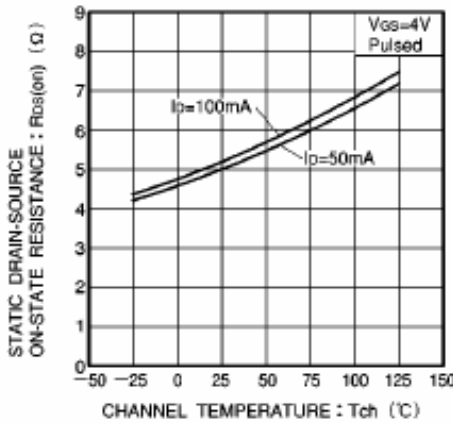

Fig.7 Static drain-source on-state resistance vs. channel temperature

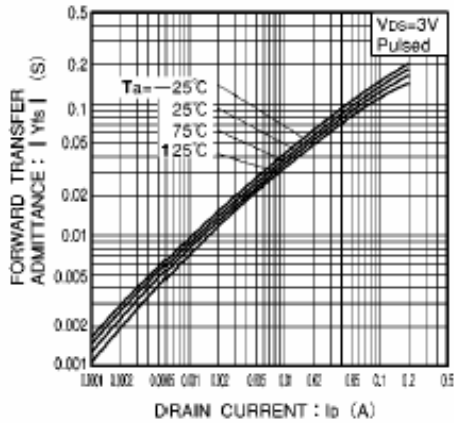

Fig.8 Forward transfer admittance vs. drain current

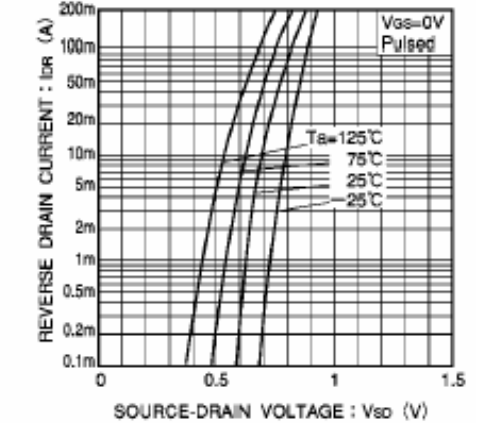

Fig.9 Reverse drain current vs. source-drain voltage (I)

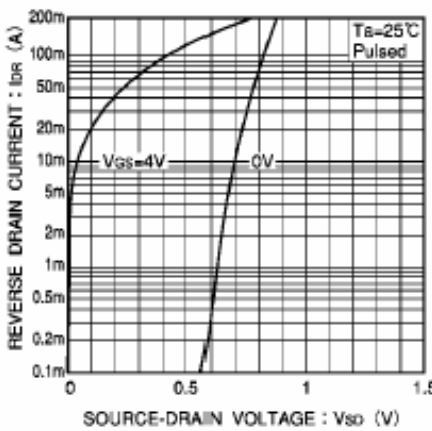

Fig.10 Reverse drain current vs. source-drain voltage (II)

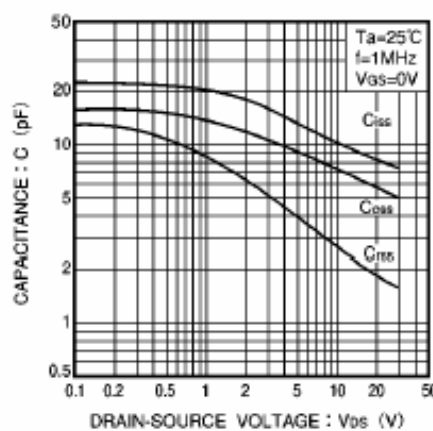

Fig.11 Typical capacitance vs. drain-source voltage

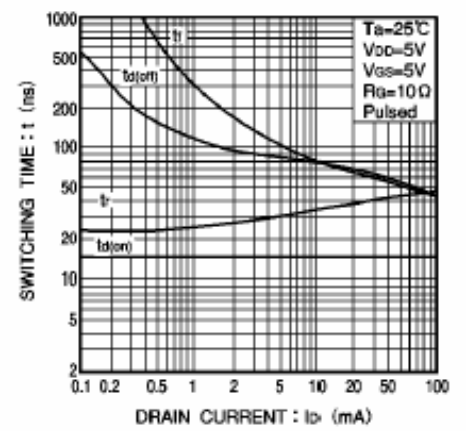

Fig.12 Switching characteristics (See Figures. 13 and 14 for the measurement circuit and resultant waveforms)

• Switching characteristics measurement circuit

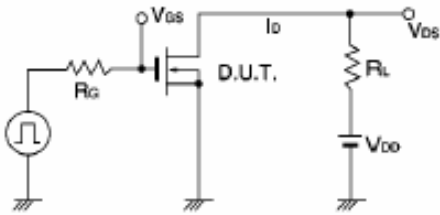

Fig.13 Switching time measurement circuit

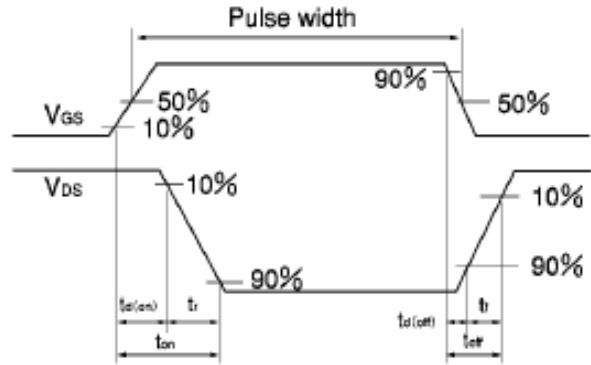

Fig.14 Switching time waveforms